

KRUPS

Il Caffè Duomo

Model #985



Instruction
Book

Warranty

Guarantee of
Performance

Krups Il Caffè Duomo

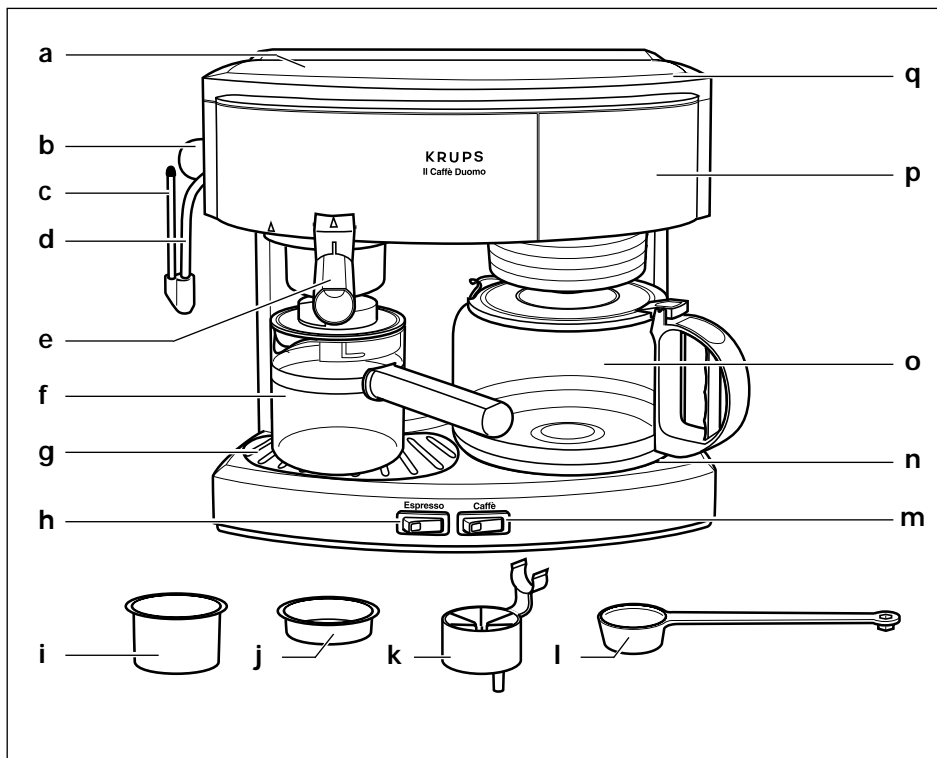

Espresso/Cappuccino

- a: boiler cap
- b: steam release knob
- c: "Perfect Froth" attachment
- d: steam nozzle
- e: filter holder with protective thumb guard
- f: glass carafe with lid
- g: removable overflow grid
- h: "on/off" switch - espresso
- i: filter basket
- j: steam build-up plug
- k: cup adapter for brewing directly into two cups
- l: measuring scoop

Coffee

- m: "on/off" switch - coffee
- n: warming plate
- o: glass carafe with lid
- p: swivel filter
- q: hinged lid

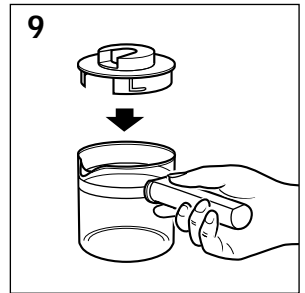
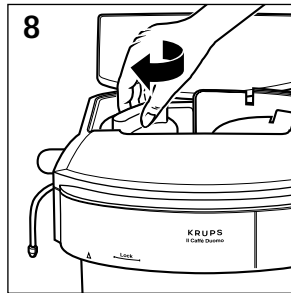
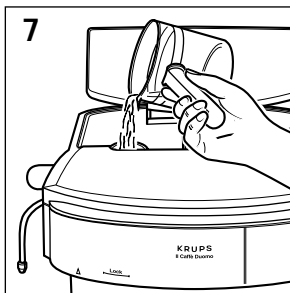
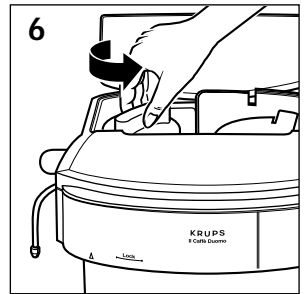
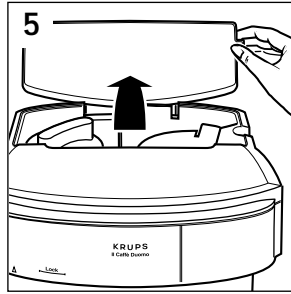
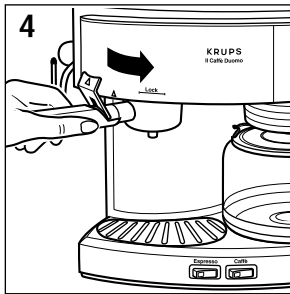
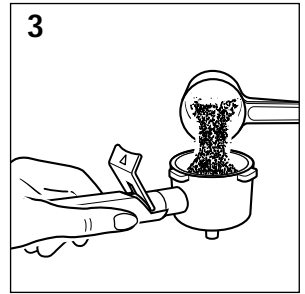
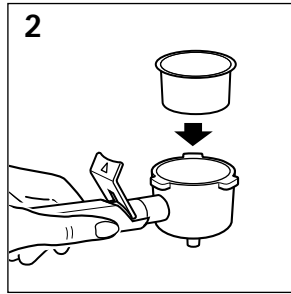
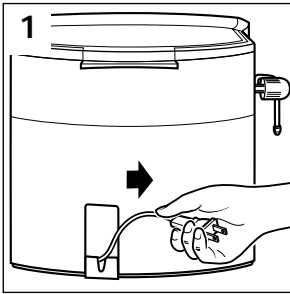

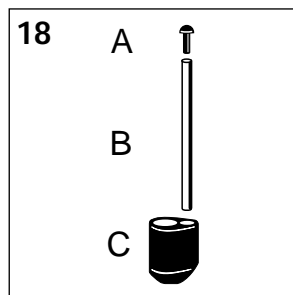
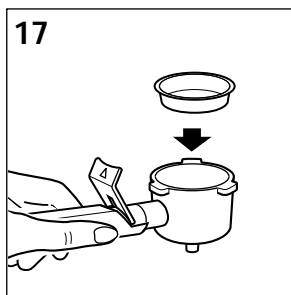
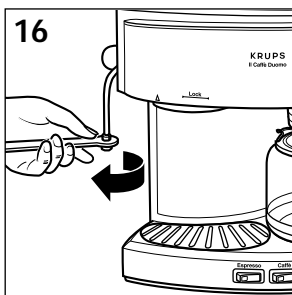
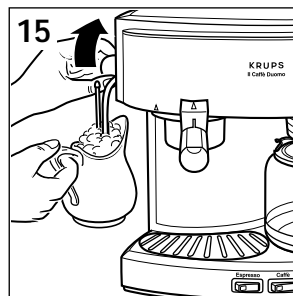
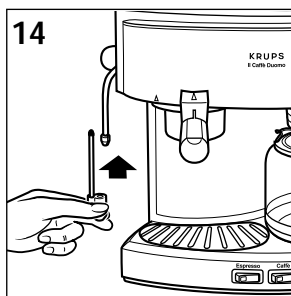
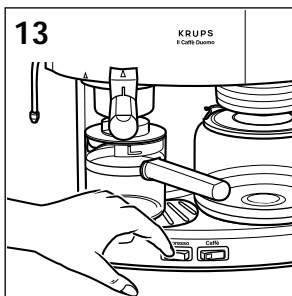
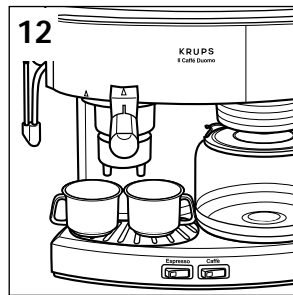
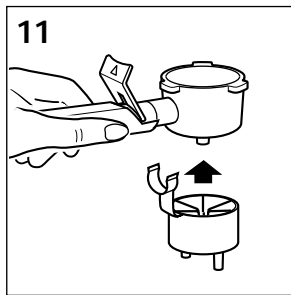
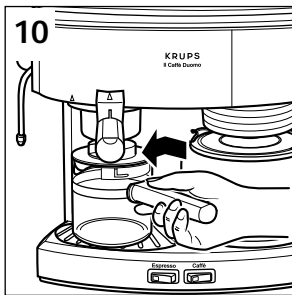

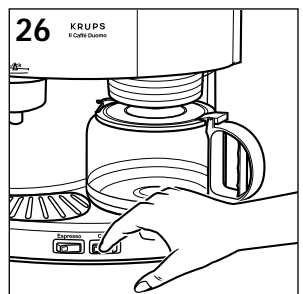
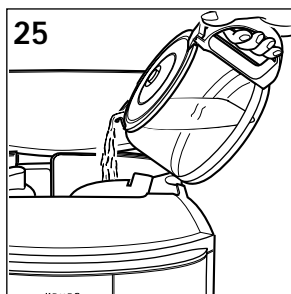
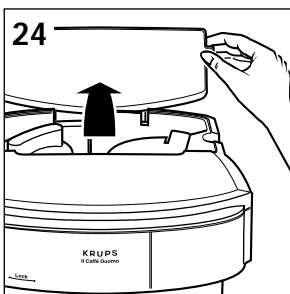
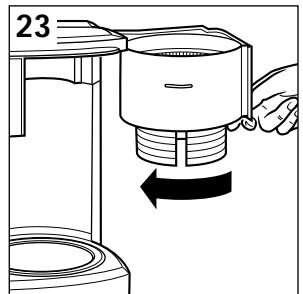
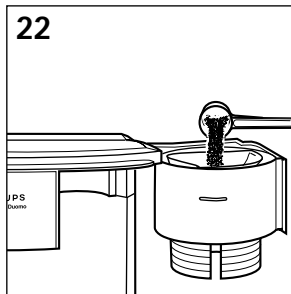
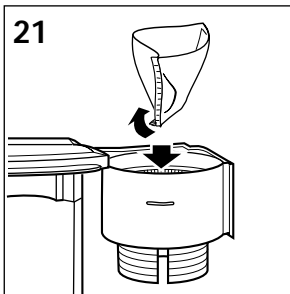
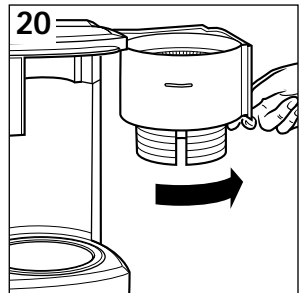
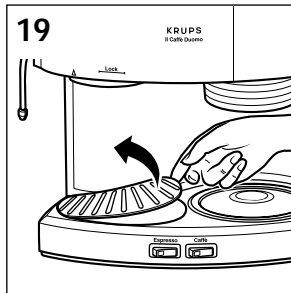

IMPORTANT SAFEGUARDS

When using electrical appliances, basic safety precautions should always be followed to reduce the risk of fire, electric shock, and/or injury to persons, including the following:

- Read all instructions and information in this instruction book and any other literature included in this carton referring to this product before operating or using this appliance.
- Do not touch hot surfaces. Use handles or knobs.
- To protect against fire, electric shock and personal injury do not immerse cord, plugs, or appliance in water or other liquid.
- Close supervision is necessary when any appliance is used by or near children.
- Unplug from outlet when not in use and before cleaning. Allow to cool before putting on or taking off parts, and before cleaning the appliance.
- Do not operate any appliance with a damaged cord or plug or after the appliance malfunctions, or has been damaged in any manner. Return appliance to your nearest authorized KRUPS Service Center for examination, repair or adjustment (see GUARANTEE OF PERFORMANCE).
- The use of an accessory not evaluated for use with this appliance may cause injuries.
- Do not use outdoors.
- Do not let cord hang over edge of table or counter, or touch hot surfaces.
- Do not place on or near a hot gas or electric burner, or in a heated oven.
- To disconnect, turn any control to "off", then remove plug from wall outlet.
- Do not use appliance for other than intended use.
- Do not unscrew or remove boiler cap while the machine is in operation. Wait until brewing cycle is completed and all water and steam has been used up.

● **Appliances with Glass Carafes.**

- A. The carafe is designed for use with this appliance. It must never be used on a range top.
- B. Do not set a hot carafe on a wet or cold surface.
- C. Do not use a cracked carafe or a carafe having a loose or weakened handle.
- D. Do not clean carafe with cleansers, steel wool pads, or other abrasive material.

SAVE THESE INSTRUCTIONS

SPECIAL CORD SET INSTRUCTIONS

Regarding your Cord Set:

- A. A short power-supply cord is to be provided to reduce risks resulting from becoming entangled in or tripping over a longer cord.
- B. Longer extension cords are available and may be used if care is exercised in their use.
- C. If a long extension cord is used, (1) the marked electrical rating of the extension cord should be at least as great as the electrical rating of the appliance, (2) if the appliance is of the grounded type, the extension cord should be a grounding-type 3-wire cord, and (3) the longer cord should be arranged so that it will not drape over the counter top or table top where it can be pulled on by children or tripped over.
- D. This appliance has a polarized plug (one blade is wider than the other). As a safety feature, this plug will fit in a polarized outlet only one way. If the plug does not fit fully in the outlet, reverse the plug. If it still does not fit, contact a qualified electrician. Do not attempt to defeat this safety feature.

CAUTION

This appliance is for household use. Any servicing other, than cleaning and user maintenance should be performed by an authorized service representative.

- Do not immerse this coffeemaker in water or any other liquid.
- To reduce the risk of fire or electric shock, do not remove the base. No user serviceable parts inside. Repair should be done by authorized service personnel only.
- Check voltage to be sure that the voltage indicated on the name plate agrees with your voltage.
- Never use warm or hot water to fill the water container! Use cold water only!
- Never refill the water chamber while this coffeemaker is in the "on"-position. Turn the coffeemaker off and let it cool down for ten minutes before refilling with water.
- Do not place carafe on a hot surface or in a heated oven.
- Before turning your KRUPS coffeemaker on, please make sure that carafe sits flat on inside circle of heating plate.
- Never remove carafe before brewing is completely finished (this is the case when dripping from the filter holder into the carafe has stopped completely.)
- Keep your hands and the cord away from hot parts of the appliance during operation.
- Never clean with scouring powders or hard implements.

Before First Use

We recommend that you get familiar with all the parts of your KRUPS espresso machine before using it for the first time. Insert the filter basket into the filter holder, fit the filter holder into the filter rings, remove and replace the boiler cap. Check the different positions of the switch. To remove any residuals of production which may rest in the appliance, we recommend operating the espresso maker (as described in "Making Espresso" section) once or twice with water only, without ground espresso coffee. Wash all loose parts in warm soapy water, rinse thoroughly and dry.

Read all instructions, cautions, notes and attentions before actually using the machine.



CAUTION - PRESSURE

Never open boiler cap (a) or remove filter holder (e) while your "Il Caffè Duomo" is turned "on" or as long as there is pressure in the boiler container.

Never move or remove the filter holder while the "Il Caffè Duomo" is in operation and under pressure.

Please follow the instructions listed below to see if the machine is still under pressure. Follow these safety precautions while your machine is in use and ten to fifteen minutes after last use.

- Turn the "on/off" switch to the "off" position and unplug appliance.
- Carefully open the steam release knob (b) by slowly turning it counter clockwise. If steam comes out of the nozzle, then the boiler chamber is still under pressure. Close steam knob and proceed with instructions listed below.
- Take a pitcher filled with cold water and hold it underneath the steam nozzle with nozzle inserted into the pitcher. Then open the steam release knob (b) by turning it counter clockwise. Leave steam release knob open until no more steam comes out of nozzle. When finished turn steam knob clockwise to close.
- Now you can remove the boiler cap and the filter holder.

Genuine Espresso

Espresso is a far richer and stronger brew than regular coffee. It should be deep, dark, and delicious. Most people find that they enjoy it in small quantities because of its richness, and for that reason, espresso is usually served in small (2-2 1/2 oz) demicups.

Your "Il Caffè Duomo", properly used, will always produce espresso that is deep, dark, and delicious. Just follow the instructions and use fresh, well-roasted, pre-ground espresso or espresso beans you grind yourself.

Preparing espresso or cappuccino is different from brewing regular drip coffee. One main difference is that the water will come to a boil and will then be forced through the ground coffee. This means that an espresso machine works under pressure and needs special attention.



CAUTION - HOT

Do not touch boiler cap (a) during operation. Before removing boiler cap turn off machine, let it cool down for at least 2 or 3 minutes. Relieve pressure. See CAUTION - PRESSURE.

Making Espresso

1. Place your "Il Caffè Duomo" near an electrical outlet and release enough cord so that you can plug in the machine (see figure 1).
2. Place the filter basket (i) into the filter holder (e) (see figure 2).
3. Fill with ground espresso. The filter basket is marked on the inside for 2 and 4 cups. Pack the coffee lightly and clear any excess coffee from the rim of the filter holder. This will assure proper fit to the brewing head (see figure 3).

ATTENTION:

Do not pack coffee too tightly.

Do not fill more coffee than indicated by the four-cup marking into the filter basket. This might cause clogging or overflow.

4. To insert the filter holder, line up the arrow located on the thumb guard of the filter holder with the arrow on the left side of the machine.
Raise the filter holder up into brewing head and turn the filter holder firmly to the right, until it can go no further. The arrow on the filter holder should be as far right in the lock-range as possible. If the arrow is not at least in the middle of the lock-range, do not operate the machine. Rather, remove the filter holder and reinsert it as described above until the arrow is within the lock-range (see figure 4).

By following this procedure this will prevent the filter holder from being dislodged as pressure builds up during the brewing process.

5. Open the hinged lid and unscrew the boiler cap by turning it counterclockwise (see figure 5 + 6).
6. Fill the boiler container with cold water using the markings indicated on the glass carafe (see figure 7).

CAUTION

**Never fill the boiler while your "Il Caffè Duomo" is switched on.
Never fill more than 20 oz of water into the boiler.**

The glass carafe has markings for 2 and 4 cups:

- 2 cups of water = 2 cups of espresso
- 3 cups of water = 2 cups of espresso, plus steam for frothing milk for cappuccino
- 4 cups of water = 4 cups of espresso.

Maximum capacity to the bottom of the metal band around the glass carafe = 4 cups of espresso, plus steam for frothing milk for cappuccino.

CAUTION:
Never fill the carafe above the bottom of the metal band!

NOTE

It is very important to fill only the amount of water you need into the boiler. Your "Il Caffè Duomo" will always need to process **all the water** until the boiler is empty.

7. Close the boiler cap securely by turning it clockwise (see figure 8). Place carafe lid on carafe so that the lid opening points towards the pouring spout of the carafe (see figure 9).
8. Place carafe under the filter holder (see figure 10).

ATTENTION:

Make sure the overflow grid is in place.

9. Should you choose to make espresso directly into two cups, clip the two cup adapter onto the filter holder and make sure that the cups are placed correctly underneath the spouts (see figure 11 + 12).

10. Turn the espresso "on/off" switch (h) "on" (see figure 13).

It will take approximately 2 minutes for the water to be heated. The water will then be forced through the ground coffee into the glass carafe or cups.

11. Wait until all the water in the boiler has been used. Switch off the machine.
12. **Do not unscrew the boiler cap while the machine is in operation. Wait until brewing cycle is completed and all water and steam has been used (See CAUTION - PRESSURE).**

CAUTION:

Use caution when removing the filter holder, as the metal parts may still be hot. To remove the filter holder, turn the filter to the left, past the "lock" markings, until the holder dislodges from the machine.

Cappuccino

Cappuccino reportedly takes its name from the chocolate hues of the robes worn by the Capuchin monks who favored this delicious dessert coffee. Cappuccino is traditionally made up of 1/3 espresso, 1/3 steamed milk and 1/3 froth and can be tailored to one's own taste with cinnamon, sugar, chocolate flakes, or even liquor. Its versatility makes cappuccino a worldwide gourmet choice.

Making Cappuccino

■ If the “Perfect Froth” is not attached, attach it now (see figure 14).

1. Pour 4 to 6 oz of fresh, cold milk into a small pitcher. The pitcher should fit underneath the steam nozzle. We recommend using 2 % or skim for a stiff, dense froth. Use regular whole milk if you prefer a creamy froth.
2. Follow the directions from step 1 to 12 in section “Making Espresso”.
3. As soon as the first few drops of coffee are forced through the filter holder you can start frothing the milk. Place the tip of the steam nozzle half way into the pitcher of milk.
- 4.a) Turn the steam release knob counterclockwise to release steam (see figure 15).

b) Keep the pitcher slightly tilted so that you can always see the position of the nozzle as you froth the milk.

In just a few seconds, your milk will begin to froth. As the froth rises, keep lowering the pitcher so that the tip of the steam nozzle is always just slightly beneath the surface of the rising froth.

Note: Do not bring milk to a boil (this will happen if large bubbles start to form on the surface of the milk).

- c) When you have finished frothing milk, close the steam release knob by turning it clockwise while the nozzle is still immersed in the milk. This will avoid splattering of the hot milk and froth.
- d) If you prefer “stiff” froth, let the frothed milk stand for a minute.

ATTENTION:

Clogged up steam nozzle

Milk residuals will build up in the tip of the steam nozzle after frothing milk. It is very important that you wipe the steam nozzle with a damp cloth after each use. This will help prevent the steam nozzle from clogging and will ensure perfect frothing results. However, should the steam nozzle become clogged, proceed as follows:

Let the steam nozzle cool down. Unscrew the tip and clean under warm water.

To unscrew the tip, use the opening in the measuring spoon. Make sure that the inside of the tip of the steam nozzle is free, so that the steam can pass freely to froth milk again.

■ Replace the tip of the nozzle and screw on tightly (see figure 16).

Steaming without making Espresso (Steampug)

CAUTION

Make sure your “Il Caffè Duomo” is cool and all pressure has been released (see CAUTION - PRESSURE).

1. Insert the steam build-up plug into the filter holder (see figure 17).
2. Fill the boiler container with cold water.

CAUTION:

For steam only, do not fill the glass carafe above the 2-cup marking. This amount will always provide enough steam for frothing.

3. Have your pitcher with milk ready to heat.
4. Place glass carafe, with lid, under filter holder and turn machine “on” (see figure 13).
5. Open the steam release knob immediately after turning the machine on. Stand by with your frothing pitcher.

CAUTION:

Do not leave the machine unattended at this time.

It will take approximately 30 to 60 seconds after turning the machine on for the steam to come out of the steam nozzle. Proceed with steps 4.a) and 4.b) in the section “Making Cappuccino”.

6. When all steam is released, close the steam release knob and turn off the machine.

Caution:

If you do not need all the water for steaming, proceed as follows:

- a) turn off the machine,
- b) release the remaining steampressure into another container.

Do not close the steam release knob before all steam is released or machine has been turned “off”!
(see section CAUTION - PRESSURE).

ATTENTION:

The top closure of the “Perfect Froth” attachment (see figure 18, part A) has a very fine hole which draws air into the milk. If this tiny hole gets clogged, “Perfect Froth” will not work properly. Therefore, never immerse the top closure in milk or froth.

Cleaning

Before cleaning, turn “off” the machine, unplug it, and allow it to cool down.

The filter holder, filter basket, carafe, carafe lid, and overflow grid can be put in the dishwasher’s upper rack, away from the heating/drying element.

The machine can be wiped clean by using a damp cloth. Never immerse the body of your “Il Caffè Duomo” in water or any other liquid. Clean the brewing head with a damp cloth and remove ground coffee. If there is water left in the boiler chamber, let the machine cool down, remove all loose parts and empty through the top opening by turning upside down.

Cleaning the Steam Nozzle

Clean the steam nozzle each time after you have immersed it in the milk, otherwise the inside of the nozzle becomes clogged and the milk deposits on the outside harden and become difficult to remove.

■ If clogging does occur, unscrew the tip of the steam nozzle (see figure 16).

Remove all milk particles using a sewing needle and rinse under the faucet. Replace nozzle tip making sure to screw it on tightly. Wipe off the outside of the nozzle with a wet cloth. Hold the wet cloth very close to the tip of the nozzle and open the steam valve. Let the steam escape into the wet cloth for one or two seconds, then close the valve. Any milk residue will then be flushed out.

Cleaning the “Perfect Froth” Attachment

■ For a thorough cleaning of the “Perfect Froth” attachment, remove part C (see figure 18).

All parts should be rinsed in warm water. If the small suction opening in part A is clogged up, it can be opened with a fine needle.

Cleaning the Drip Tray

■ The overflow grid can be cleaned by removing the grid (see figure 19).



CAUTION

Do not try to open or disassemble the main body of the machine.

Decalcifying of the espresso machine

The espresso machine must be decalcified regularly. The frequency depends on the hardness of your water and how often you use the espresso machine.

Before descaling, the brewing sieve on the brewing head **must** first be screwed off.

1. Remove all lime and coffee residues from the brewing sieve and the brewing head.
2. Pull off the “Perfect Froth” attachment.

For ecological and health reasons, we recommend the exclusive use of biological materials such as citric acid, which can be obtained from KRUPS Consumer Service Department or drugstores.

3. Dissolve 2 tablespoonfuls of citric acid in 10 fluid ounces of lukewarm water and pour it into the boiler container. Put one receptacle under the brewing head and another under the steam nozzle.
(**Note:** Do not use the filter holder during decalcification)
4. Open the steam valve and turn on the appliance. Allow the descaling solution to run out of the espresso outlet and the steam nozzle.
5. After each brewing cycle, switch off the appliance and allow the appliance to cool down.

6. Repeat this operation once again.

Following this, allow 2 boiler containerfuls of clear water to run through the system. Switch off the appliance. Allow the appliance to cool down. Insert the brewing sieve into the brewing head again and push the "Perfect Froth" onto the steam nozzle.

Problems and Causes making Espresso or Cappuccino

(Always check if the appliance is plugged in and is in the proper "on" position).

Problem:

1. Espresso leaking from filter holder.

Cause:

- Filter holder not properly inserted.
- Filter holder not pushed in far enough.
- Internal gasket is dirty and needs to be cleaned.
- Gasket without elasticity, replace it with a new one.
- Coffee powder not cleaned off the edge of the filter holder.

Problem:

2. Espresso does not come out.

Cause:

- No water in boiler container.
- No coffee in filter holder.
- Filter clogged because coffee is ground too fine and or pressed down too hard.

Problem:

3. Steam does not come out of steam nozzle.

Cause:

- No water or not enough water in the boiler chamber.
- Steam nozzle is clogged (see "Cleaning" section).
- Perfect froth attachment is clogged (see "Cleaning the Perfect Froth").

Problem:

4. Not enough froth when frothing the milk.

Cause:

- Perfect froth attachment touches the bottom of the pitcher.
- Perfect froth tip is clogged (see **figure 18, part A**). See also section "Cleaning the Perfect Froth Attachment".
- Steam nozzle is clogged (see "Cleaning")

Preparing Coffee

Before making your first pot of delicious coffee, we recommend rinsing the coffee maker by running one or two cycles with water only, without ground coffee in the filter basket. This will remove any possible dust which may have settled during shipping.

Be sure that the water chamber is empty. Remove any literature, etc if found in the water chamber.

- The lid of the glass carafe must be properly positioned during the brewing process. The front hooks have to be inside the carafe and the rectangular part of the lid to be pushed down so that it engages with the handle of the glass carafe.
- To release the lid push the rectangular part of the lid upwards.
- Make sure that the swivel filter is closed properly during the brewing process. Push in firmly until the handle touches the side of the coffee maker and filter "clicks" into place.
- **Caution:** If the swivel filter is not closed in properly the "Stop 'N Serve" can not function. This may cause hot water or hot coffee to overflow.
- The "Stop 'N Serve" mechanism is opened as long as the glass carafe is inserted into the machine and sits properly on the warming plate and the swivel filter is closed properly. When brewing coffee make sure the glass carafe is in place (see Stop 'N Serve section).

Putting in the Ground Coffee

1. Swing out the swivel filter (see figure 20) and insert a paper filter. We recommend using KRUPS size 2. When inserting a paper filter make sure the seam is pointing towards the base of the filter holder (see figure 21).

Use your hands to conform the filter to the contours of the filter holder. This will enable you to achieve better results.

2. Put ground coffee into the filter holder (see figure 22). We suggest using one level KRUPS measuring spoon of ground coffee for each cup of robust brewed coffee. After using your KRUPS coffee maker several times, you can adjust the quantity to suit your own taste.

We do not recommend using coffee that is ground to a powder-like consistency, as this will prevent water from passing through the coffee.

3. Close the swivel filter and make sure that it is completely closed (see figure 23).

ATTENTION:

Make sure that the filter paper does not fold over when closing the swivel filter, otherwise the water might run between the filter paper and the filter holder producing a very weak cup of coffee.

Filling the Water Chamber

1. Open the hinged water chamber lid (see figure 24). Pour in the desired quantity of water (see figure 25). The amount of freshly brewed coffee delivered after the brewing process will always be slightly less than the amount put into the water chamber. This is due to the minimal absorption of the water by the ground coffee. Therefore, put in a little more water to begin with so that you will have the number of cups that you desire.
2. Place the glass carafe with lid in position on the warming plate.
3. Turn "on" your "Il Caffè Duomo" using the coffee "on/off" button (m). The indicator light will illuminate indicating that the brewing process has begun (see figure 26).
4. As long as the red indicator light is illuminated the coffee will be kept warm.

Stop'N Serve Feature

The Stop 'N Serve feature is KRUPS' answer to the impatient coffee drinker's clamour for a quick cup of coffee! This device automatically stops the flow of brewed coffee through the filter cone if the glass carafe is removed from the warming plate during the brewing cycle. You have about 20 seconds between the removal of the carafe and it being reinserted back onto the warming plate.

The Stop 'N Serve device closes off the filter cone so effectively that there is virtually no coffee dripping onto the warming plate. Once the carafe is replaced, the brewing process and the flow of coffee into the carafe will resume.

CAUTION

Should significant amounts of coffee drip onto the warming plate after the removal of the carafe, it is usually an indication that the seal in the filter holder is missing or defective, in this case call the KRUPS Consumer Service Department at 1-800-526-5377 and they can assist you. It is also possible that too much ground coffee has been placed in the filter paper. This causes the water that jets into the filter cone to overflow between the filter and the sides of the filter cone.

If this blockage and subsequent dripping does occur, put the glass carafe immediately back onto the warming plate, and allow the full brewing cycle to run its course. Do not swing out the swivel filter until the brewing process is completed.

Cleaning

- Always unplug this appliance before cleaning. Clean the filter basket, carafe, and lid in a solution of warm water and mild liquid soap. These parts can also be placed in the upper level of your dishwasher away from the heating and drying element for safe effective cleaning.
- Never use scouring agents.
- Never immerse the appliance itself in water. To clean, simply wipe off with a soft, damp cloth.
- Never use a cloth to clean inside of the water chamber, as this might leave fuzzy deposits in the chamber. Just rinse with cold water periodically.

Decalcifying of the coffeemaker

The coffeemaker must be decalcified regularly. The frequency depends on the hardness of your water and how often you use the coffeemaker.

Recognizable indications that descaling is necessary are:

- increased noise during boiling
- longer preparation time.

If usage is frequent, descaling should be carried out as follows:

- with soft water once a year
- with medium hard water every quarter year
- with hard water once a month.

In doubt regarding the water hardness in your area, you may call your local water department.

For ecological and health reasons, we recommend the exclusive use of biological materials such as citric acid, which can be obtained from KRUPS Consumer Service Department or drugstores.

Dissolve 2 tablespoonfuls of citric acid in 1/2 quart water and pour into the water container. Run this through 2 or 3 times as if making coffee, but using no ground coffee.

The hot descaling solution must be allowed to cool down before being poured into the water container. Finally do the same twice using clear water.

Limited One Year Warranty

Your KRUPS #985 is covered by the following warranty:

If from date of purchase within one year this KRUPS product fails to function because of defects in materials or workmanship, KRUPS North America will, at its option, repair or replace the unit without charge, provided the owner has a proof of date of purchase.

This warranty will be void if malfunction was caused by damage to the product by accident, misuse, use on frequency or voltage other than marked on the product and/or described in the instructions, abuse including tampering, damage in transit, or use for commercial purposes. This warranty gives you specific legal rights, and you may also have other rights which may vary from state to state.

For the best result...

...always use fresh, cold water (warm water might be stale and have mineral deposits which would impair the flavor of the coffee).

...we recommend that you grind your own beans. Freshly ground beans deliver more aroma and flavor. Use one KRUPS measuring scoop of beans per cup.

...serve coffee immediately after brewing.

...never reheat coffee.

GUARANTEE OF PERFORMANCE

This fine KRUPS product is manufactured according to a rigid code of quality standards, and, with minimum care, should give years of satisfying service.

However, should the need arise for repairs or for replacement parts within or after the warranty period, please call our **CONSUMER SERVICE DEPARTMENT**:

(800) 526-5377
24-hours a day, 7 days a week

You will be provided with specific instruction on how to get your product repaired, as well as the name and address of your nearest authorized KRUPS Service Center. The department will also be able to answer any general product questions you may have.

Before calling the Consumer Service Department, please have the type number of your KRUPS appliance available. You must have this information before calling our Consumer Service Department so that we may better answer your questions. The type number can be located by looking at the bottom of your appliance.

This product is Type #985

Any general correspondence can be addressed to:

KRUPS North America, Inc.
P.O. Box 3900
Peoria, IL 61612